

RIBBON HOOK



OVERALL DIMENSIONS

H 120MM x D 74MM x W 15MM

H 4.72IN x D 2.91IN x W 0.59IN

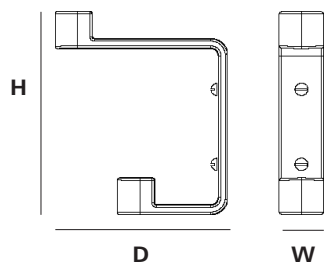

MATERIALS

I. METAL

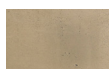

Brass



Aluminium

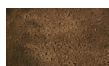

Blackened

WEIGHT

Brass
(210G / 2.47oz)

Aluminium
(70G / 7.41oz)

CLEANING INSTRUCTIONS

I. METAL

The metal used for our range oxidise with age and environment, both of which contribute to the evolution of a natural patina. If you favour the original bright finish of your pieces, this is easily restored by use of polishing solution - we recommend Braso or Silvo depending on the metal in question - applied with a soft, clean cloth.

Because each object is cast in small batches, slight variations will occur from one individual piece to another. Production marks may include slight pour ripples or surface pitting, which imprint every item with a unique character.

RIBBON HOOK

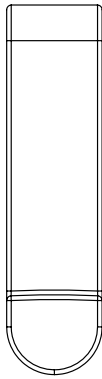

TOP

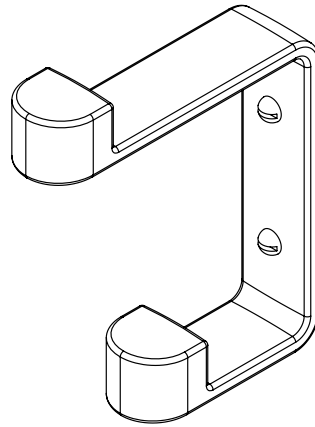

ISOMETRIC

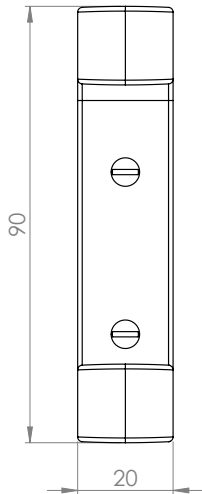

FRONT

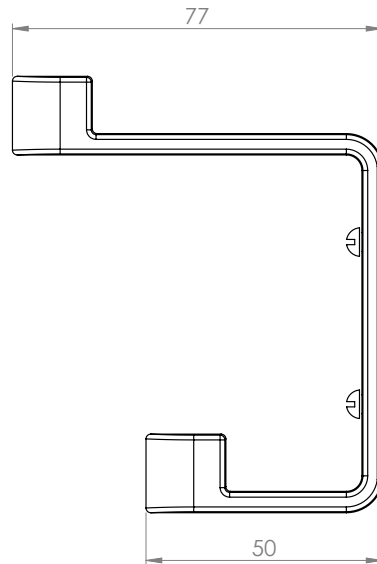

SIDE

RIBBON HOOK